

COLONNE	
POSTS COLONNES	SÄULEN COLUMNAS

(C)2011 Werther Polska
do użytku wewnętrznego
nieautoryzowane użycie prawnie zabronione

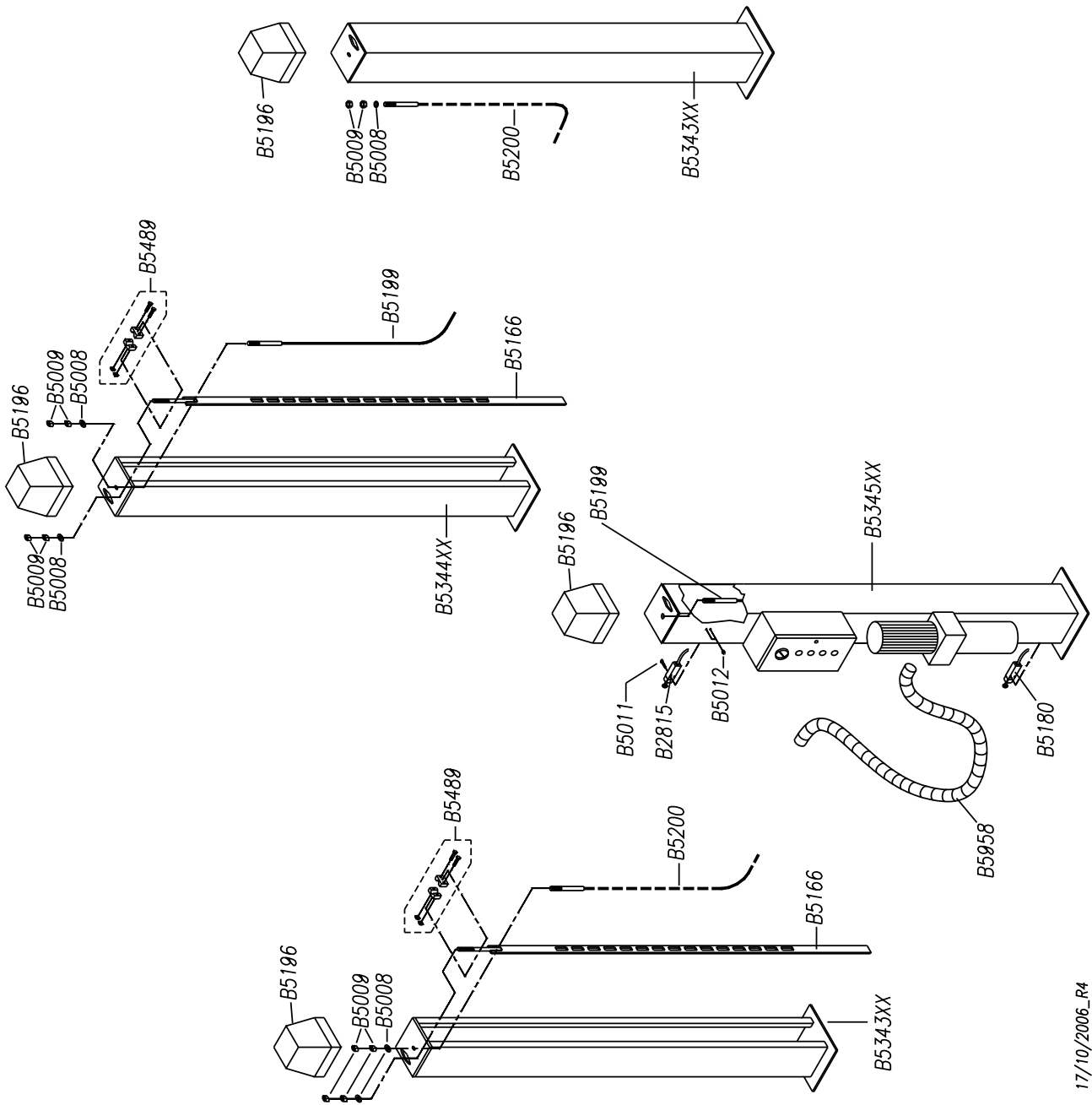

TRAVERSE	
CROSSBEAMS TRAVERSES	TRAVERSE TRAVERSAÑOS

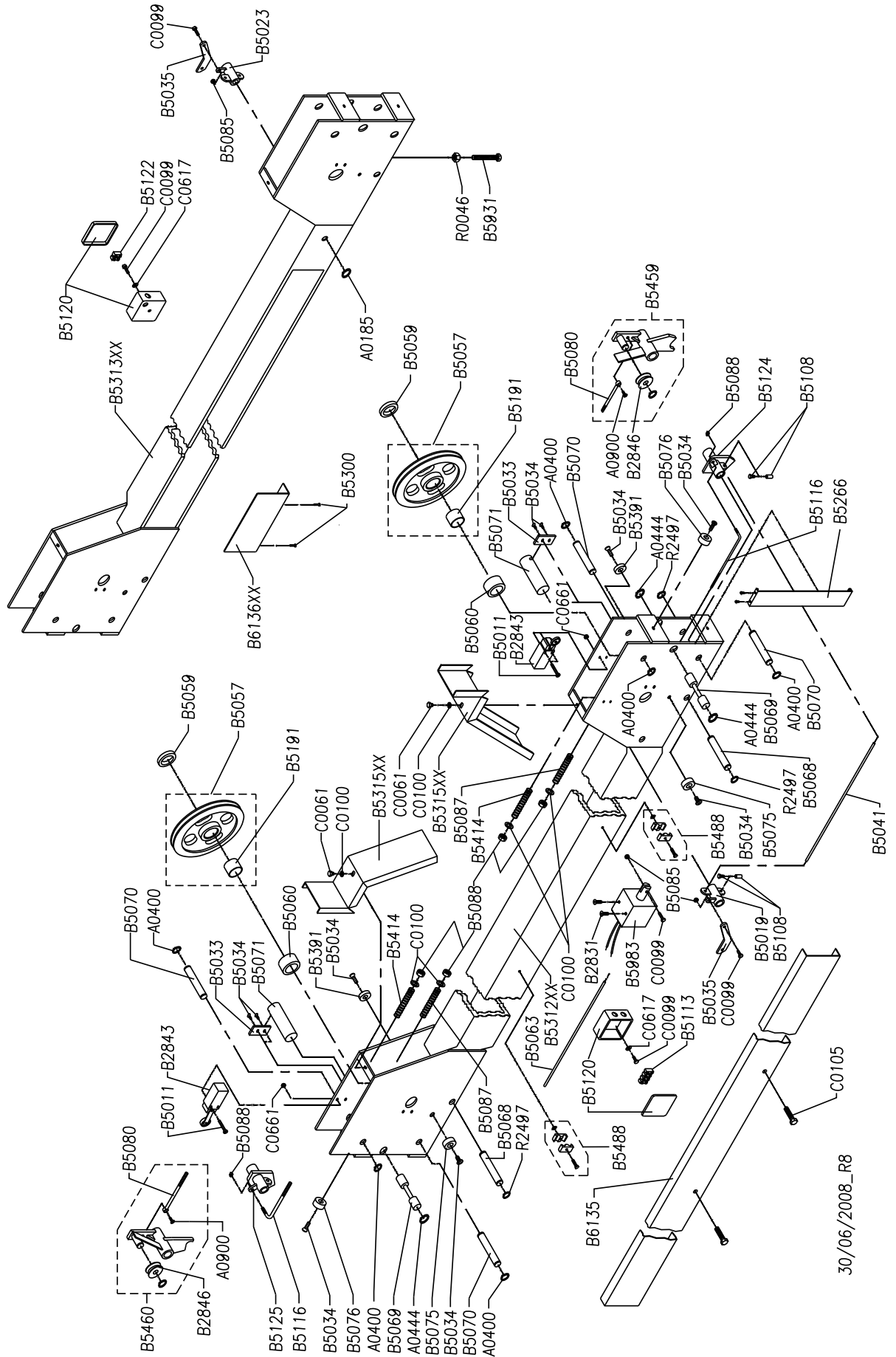

PEDANE	
PLATFORMS	FAHRSCHIENE
CHEMINS DE ROULEMENT	PLATAFORMAS

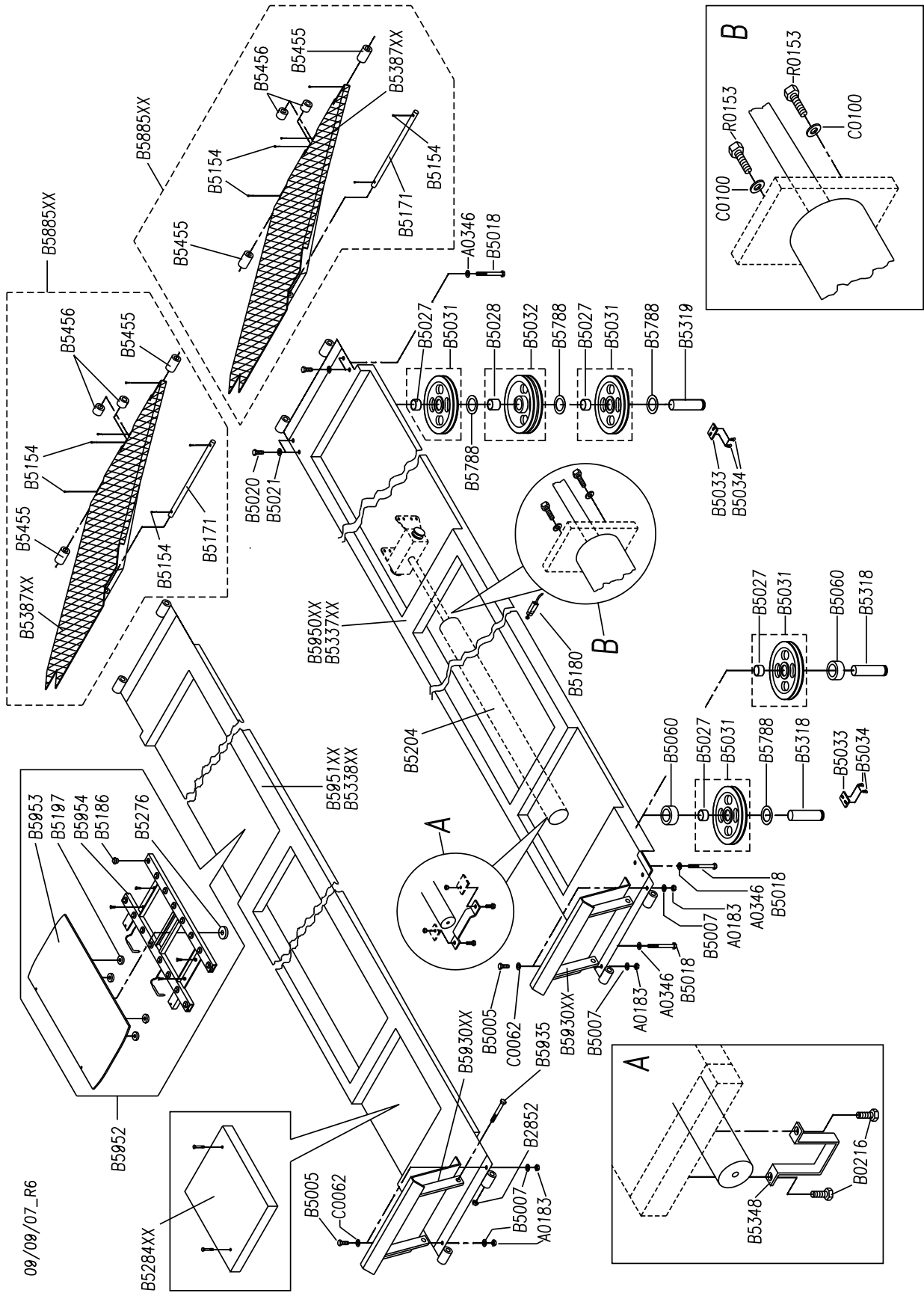

08/09/07_R6

05/06/2006_R3

LIFT TABLE	
LIFT TABLE	

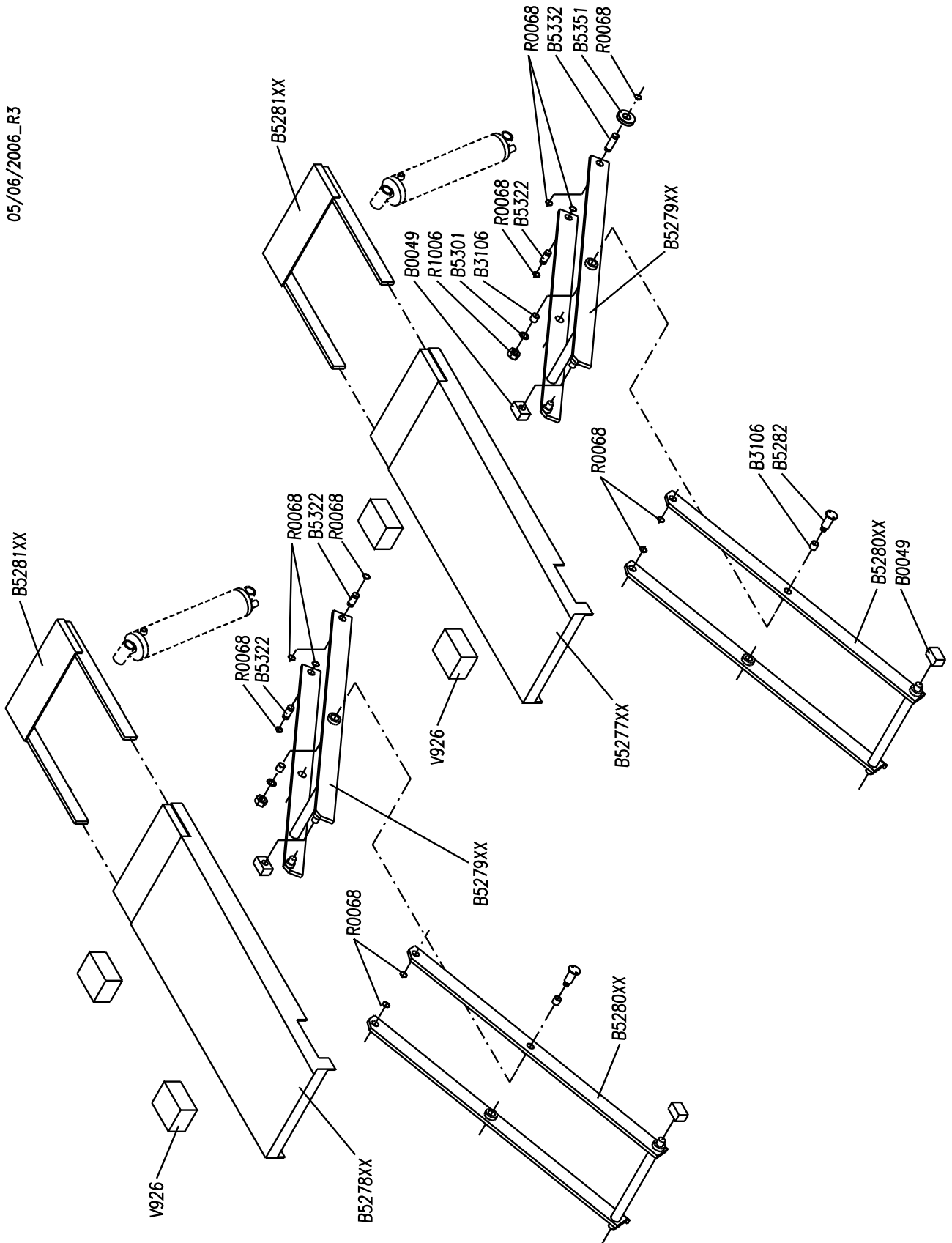

CILINDRO	
CYLINDER	ZYLINDER
VÉRIN	CILINDRO

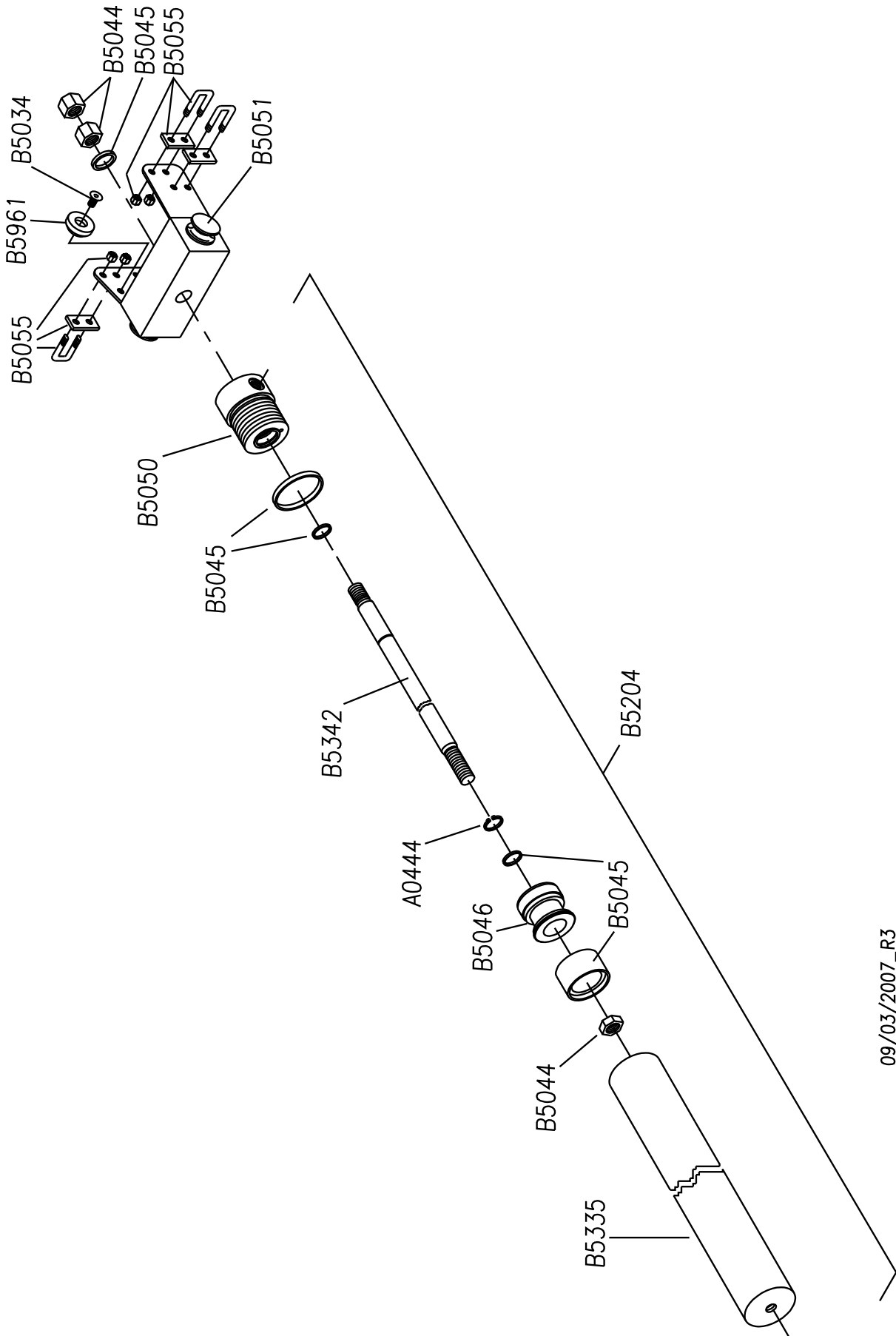

09/03/2007_R3

CILINDRI LIFT TABLE

LIFT TABLE CYLINDERS

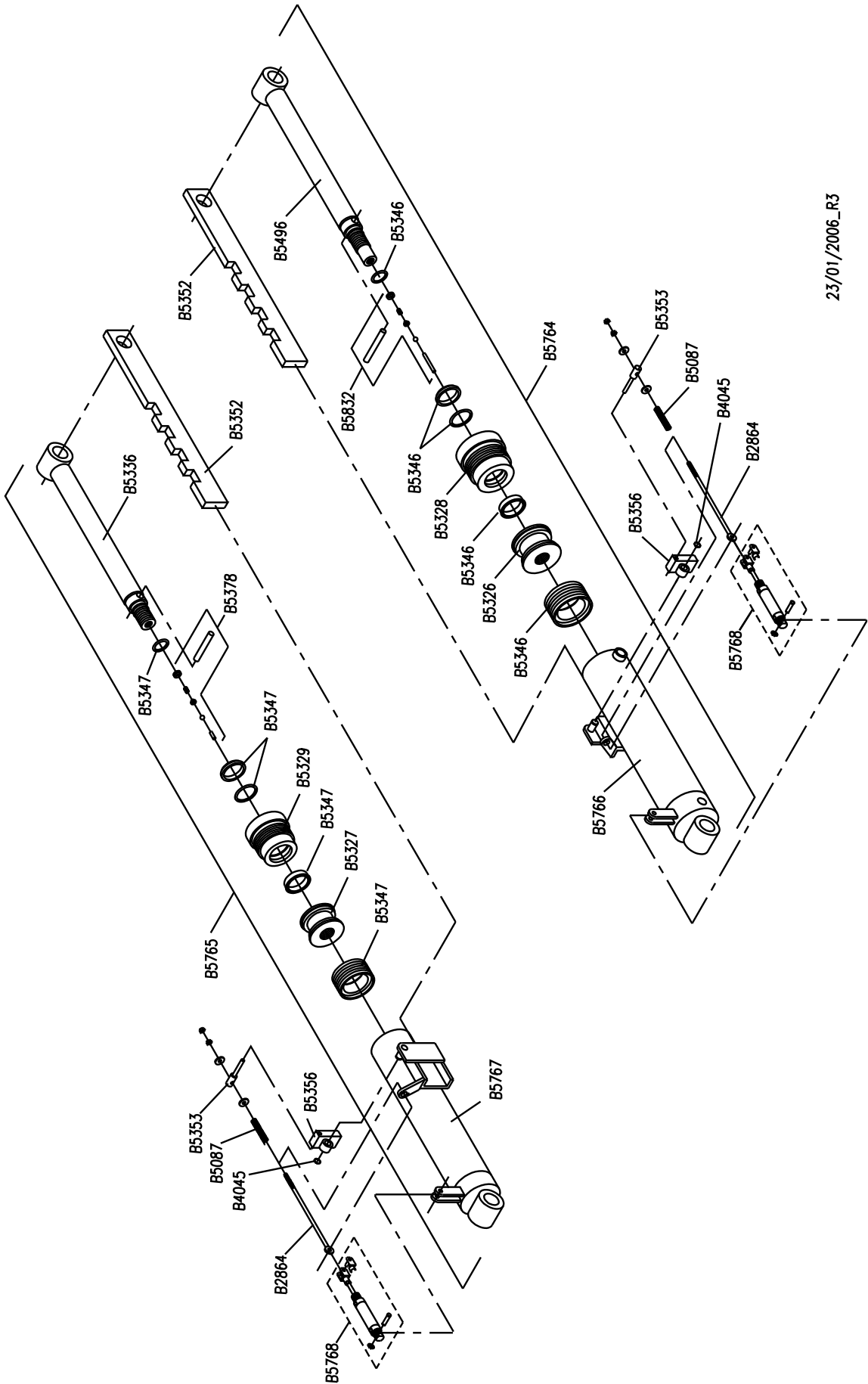

23/01/2006_R3

SISTEMA IDRAULICO

HYDRAULIC SYSTEM

30/08/2008_R6

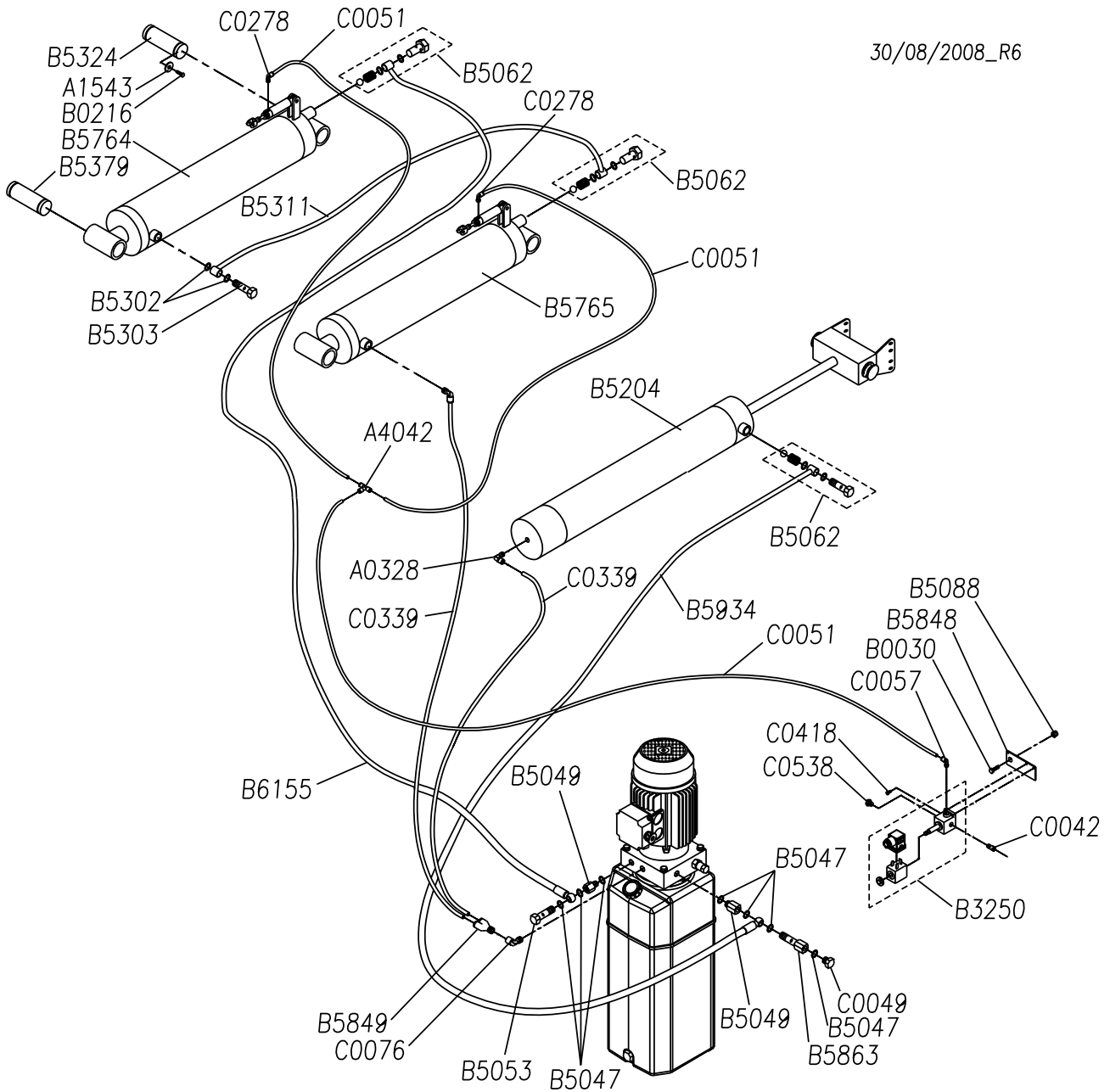

CENTRALINA OLEODINAMICA K3	
OLEODYNAMIC CONTROL UNIT K3	OELDYNAMISCHES SCHALTGEHÄUSE K3
CENTRALE HYDRAULIQUE K3	CENTRALITA OLEODINÁMICA K3

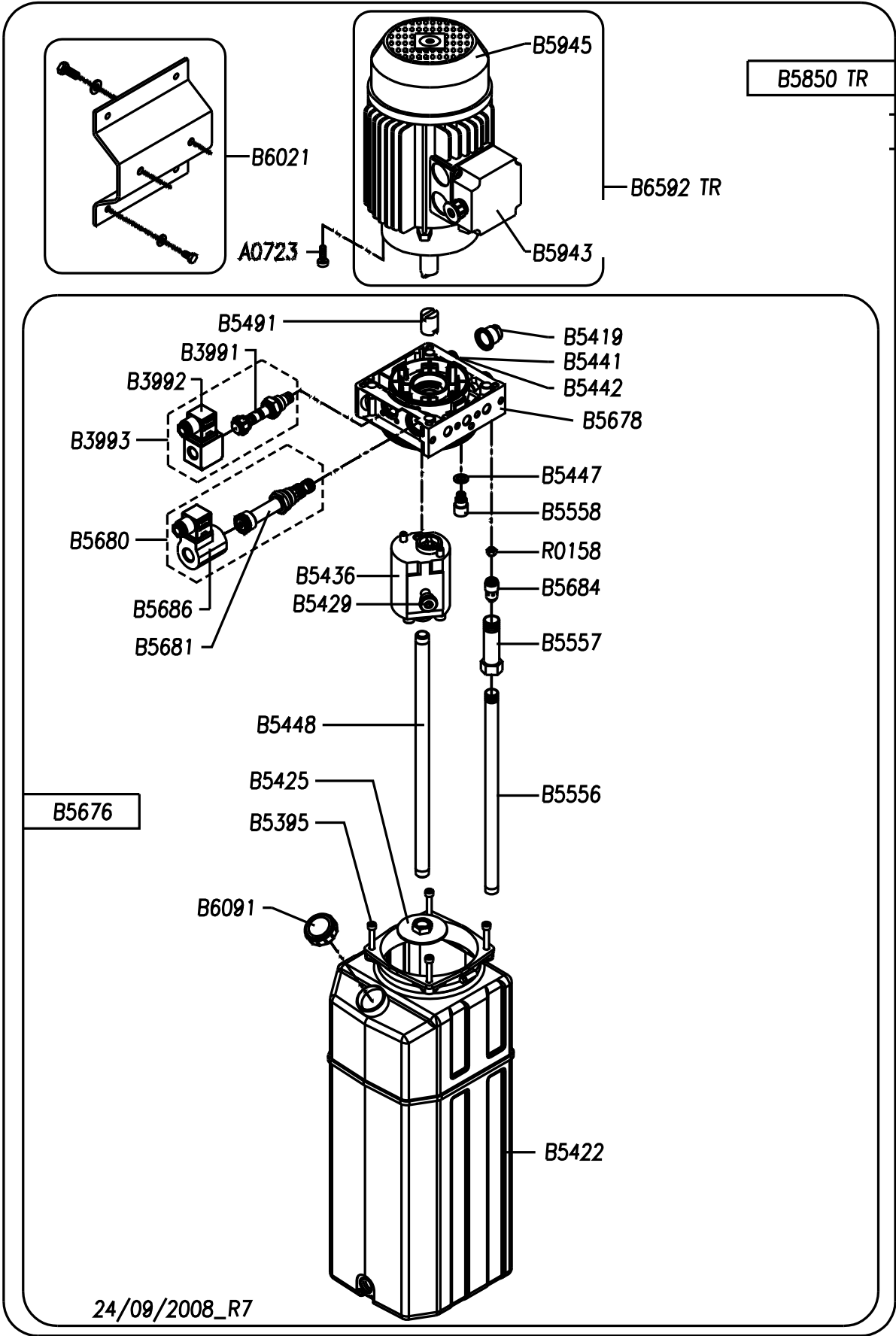

QUADRO ELETTRICO TRIFASE

CONTROL PANEL

SCHALTTAFEL DREHSTROM

COFFRET ÉLECTRIQUE

CUADRO ELECTRICO

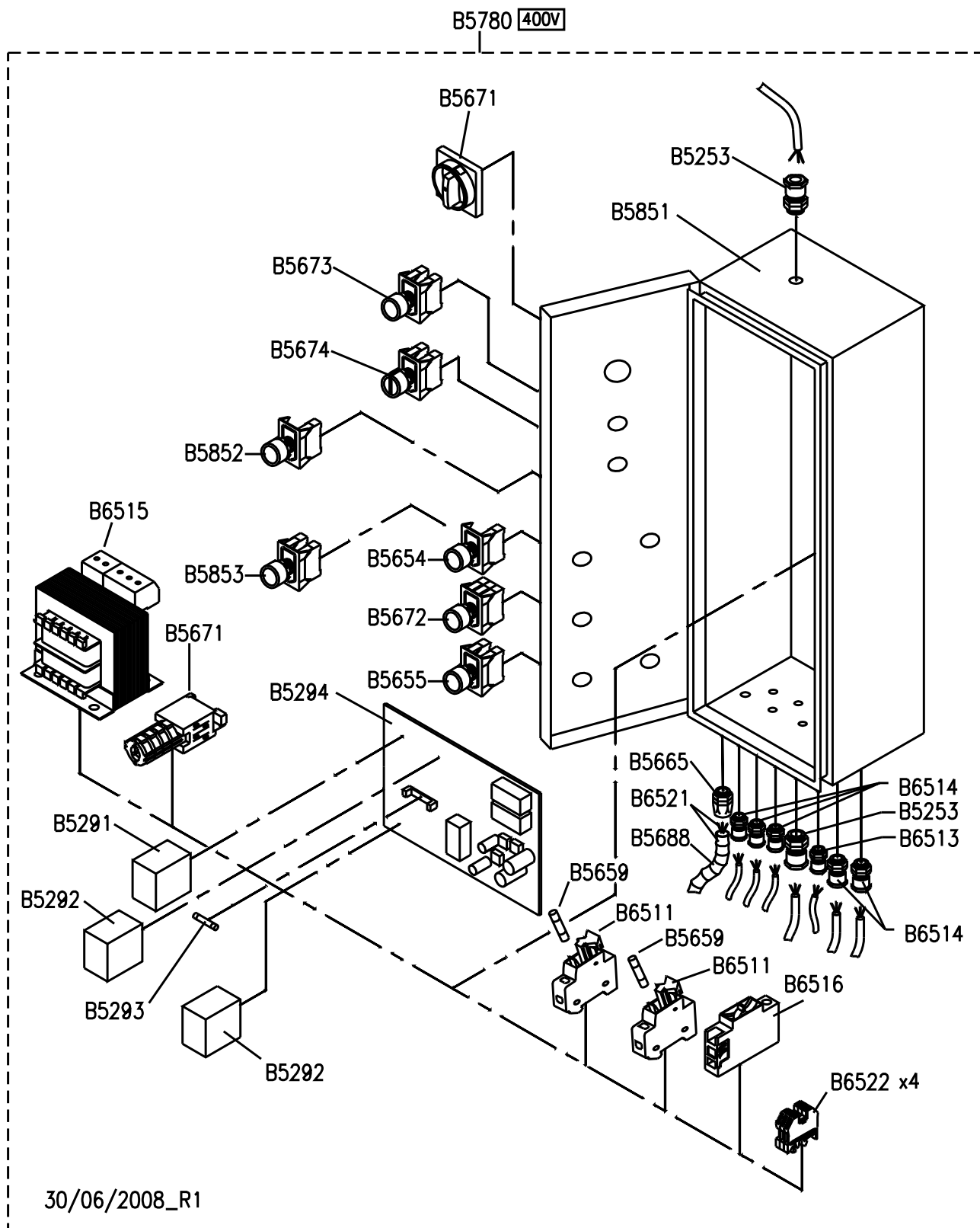

30/06/2008_R1

Part Code	Sugg	Descrizione	Description	Beschreibung	Description	Denominacion
A0183		DADO M10 UNI 5588	NUT M10 UNI 5588	MUTTER M10 UNI 5588	ÉCROU M10 UNI 5588	TUERCA M10 UNI 5588
A0185		SEEGER E18 UNI 7435	SNAP RING E18 UNI 7435	SEEGER E18 UNI 7435	ANNEAU DE FIXAGE E18 UNI 7435	SEEGER E18 UNI 7435
A0328		RACCORDO "L" 1/4" M X TUBO Ø 8	L-SHAPED COUPLING 1/4" M FOR PIPE Ø 8	"L" ANSCHLUSSKEGELG1/4"-Ø8	RACCORD "L" G 1/4" - Ø8	RACOR "L" 1/4" M PARA TUBO Ø 8
A0346		RONDELLA P 12 X 24 UNI 6592	WASHER 12 X 24	UNTERLEGSCHIEBE 12 X 24	RONDELLE Ø13X24	ARANDELA 13X24
A0400		SEEGER E20 UNI 7435	SNAP RING E20 UNI 7435	SEEGER-RING E20 UNI 7435	CIRCLIPS E 20 UNI 7435	SEEGER E20 UNI 7435
A0444		SEEGER E25 UNI 7435	SEEGER E25 UNI 7435	SEEGER E25 UNI 7435	ANNEAU ÉLASTIQUE ØE 25	ARO ELÁSTICO ØE 25
A0723		VITE TCEI M8X20 UNI 5931	SCREW TCEI M8X20 UNI 5931	SCHRAUBE TCEI M8X20 UNI 5931	VIS TCHC M8X20 UNI 5931	TORNILLO TCEI M8X20 UNI 5931
A0900		VITE TSPEI M6 X 18 UNI 5933	SCREW M6 X 18 UNI 5933	SCHRAUBE TSPEI M6 X 18 UNI 5933	VIS TFHC M6 X 18 UNI 5933	TORNILLO TSPEI M6X18 UNI 5933
A1543		RONDELLA P 8 (9X24X2) UNI 6593 ZB	WASHER 8 (9X24X2)	SCHEIBE 8 (9X24X2) UNI 6593	RONDELLE8 (9X24X2)	ARANDELA
A4042		RACCORDO RAPIDO "T" Ø6 S6540	QUICK "T" CONNECTION Ø6 S6540	FITTING "T" D6	RACCORD EN T D6	CONEXION "T" D 6
B0030		VITE TE M8X16 UNI 5739	SCREW TE M8X16 UNI 5739	SECHSKANTSCHRAUBE M8X16 UNI 5739	VIS TH M8X16 UNI 5739	TORNILLO TE M8X16
B0049	*	PATTINO DI SCORRIMENTO	SLIDE PAD	GLEITBACKE	PATIN	PATÍN
B0216		VITE TE M8X12 UNI 5739 ZB	SCREW TE M8X12 UNI 5739	SCHRAUBE M8X12 UNI 5739	VIS TH M8X12 UNI 5739	TORNILLO TE M8X12 UNI5739
B2815	*	FINECORSAL SALITA TIPO PIZZATO FR654	ASCENT LIMIT SWITCH TYPE PIZZATO FR654	AUFSTIEGENDSCHALTER TYP PIZZATO FR654	FIN DE COURSE HAUT PIZZATO FR 654	MICROINTERRUPTOR FR 654
B2831		VITE TSCE 90° M6X14 UNI 5933	SCREW M6X14 UNI 5933	SCHRAUBE M6X14 UNI 5933	VIS M6X14 UNI 5933	TORNILLO M6X14 UNI 5933
B2843	*	FINECORSAL SICUREZZA TIPO PIZZATO FR1454	SAFETY SWITCH TYPE PIZZATO FR1454	MIKROSCHALTER TYP PIZZATO FR 1454	FIN DE COURSE HAUT PIZZATO FR 1454	MICROINTERRUPTOR FR1454
B2846		PULEGGIA	PULLEY	RIEMENSCHIEBE Ø50 FÜR KABELSENSOR	POULIE Ø50 CAPTEUR CABLE	POLEA Ø 50 SENSOR CABLE
B2852		DADOBLK BASSO M12 6S. UNI 7474	SELF-LOCKING NUT M12	SELBSTSICHERNDE MUTTER M12	ÉCROU FREIN M 12 UNI 7474	TUERCA AUTOBLOCANTE M12 6S. UNI 7474
B2864		TIRANTE AZIONAMENTO ELETTROMAGNETE	MAGNET OPERATING CABLE	ZUGSTANGE BETÄTIGUNG ELEKTROMAGNET	TIRANT D'ÉLECTRO-AIMANT	TIRANTE
B3106		BOCCOLA AUTOLUBR.30X34X30	SELF-LUBRICATING BUSHING Ø30X34X30	SELBSTSCHMIERENDE BUCHSE D 30X34X30	DOUILLE AUTOLUBRIFIANTE Ø30X34X30	CASQUILLO AUTOLUBRIC. DIAM. 30X34X30
B3250		MICROVALVOLA PNEUMATICA	PNEUMATIC MICROVALVE	DRUCKLUFTMIKROVENTIL	MICRO VANNE PNEUMATIQUE	MICRO-VÁLVULA NEUMÁTICA
B3991	*	VALVOLA VE1-NC-EM	VALVE	VENTIL	SOUPAPE	VÁLVULA
B3992	*	BOBINA S2-CE 24VRAC 50/60HZ +CONNETTORE RADDRIZZATO	COIL	SPULE	BOBINE	BOBINA
B3993	*	EL.VALV.COMPL.VE1-NC-EM 24VRAC CENTR. K3	COMPLETE ELECTRO-VALVE HYDRAULIC POWER K3	ELEKTROVENTIL	ELECTROVANNE COMPLÈTE	ELECTROVÁLVULA
B4045		ANELLO SEEGER E12 UNI 7435	SEEGER E12 UNI 7435	SEEGER-RING E12 UNI 7435	ANNEAU DE FIXAGE E12 UNI 7435	SEEGER E12 UNI 7435
B5005		VITE TE M10X25 UNI 5739	SCREW TE M10 X 25	SCHRAUBE TE M10 X 25	VIS TH M10 X 25	TORNILLO TE M10X25
B5007		RONDELLA P 10 X 30 UNI 6593	WASHER 10 X 30 UNI 6593	UNTERLEGSCHIEBE 10 X 30 UNI 6593	RONDELLE PLATE 10 X 30 UNI 6593	ARANDELA 10X30 UNI 6593
B5008		RONDELLA P 21X37X3 UNI 6592	WASHER Ø21X37X3 UNI 6592	UNTERLEGSCHIEBE Ø21X37X3 UNI 6592	RONDELLE PLATE 21X37 UNI 6592	ARANDELA 21X37 UNI 6592
B5009		DADO M20 UNI 5588	NUT M20 UNI 5588	MUTTER M20 UNI 5588	ECROU M20 UNI 5588	TUERCA M20 UNI 5588
B5011		VITE TCCE M5X35 UNI 5931	SCREW M5X35 UNI 5931	SCHRAUBE TCCE M5X35 UNI 5931	VIS TCCE M5X35 UNI 5931	TORNILLO TCCE M5X35 UNI 5931
B5012		DADO CIECO M5 UNI 5721	BLANK NUT M5 UNI 5721	MUTTER M5 UNI 5721	ECROU BORGNE M5 UNI 5721	TUERCA CIEGA M5 UNI 5721
B5018		VITE TE M12 X 100 UNI 5737	H.H. SCREW M12 X 100 UNI 5737	SCHRAUBE TE M12 X 100 UNI 5737	VIS TE M12 X 100 UNI 5737	TORNILLO TE M12X100 UNI 5737
B5019		PERNO AZIONAMENTO T.L.C. W435	COMMAND SIDE CROSS PIN	STIFT T.L.C.	GOUJON D'ACTIONNEMENT T.L.C	PERNO ACCIONAMIENTO T.L.C.
B5020		VITE TE M12X25 UNI 5739	SCREW TE M12X25 UNI 5739	SCHRAUBE TE M12 X 25 UNI 5739	VIS TE M12X25 UNI 5739	TORNILLO TE M12X25 UNI 5739
B5021		RONDELLA DE Ø12 DIN 6798 A	WASHER OD Ø12 DIN 6798 A	UNTERLEGSCHIEBE D 12 UNI 6798A	RONDELLE DE Ø12 DIN 6798 A	ARANDELA DE Ø12 DIN 6798 A
B5023		PERNO AZIONAMENTO T.L.O. W435	OPPOSITE SIDE CROSS PIN	STIFT T.L.O.	GOUJON D'ACTIONNEMENT T.L.O.	PERNO ACCIONAMIENTO

B5027	*	BRONZINA Ø 40 X 44 X 20 MBI - CB85 - 4020	BUSHING Ø 40 X 44 X 20 MBI - CB85 - 4020	LAGERBUCHSE Ø 40 X 44 X 20 MBI - CB85 - 4020	COUSSINET Ø 40X44X20 MBI - CB85 - 4020	COJINETE Ø 40X44X20 MBI-CB85-4020
B5028	*	BRONZINA Ø 40 X 44 X 30 MBI - CB85 - 4030	BUSHING Ø 40 X 44 X 30 MBI - CB85 - 4030	LAGERBUCHSE Ø 40 X 44 X 30 MBI - CB85 - 4030	COUSSINET Ø 40X44X30 MBI - CB85 - 4030	COJINETE Ø 40X44X30 MBI-CB85-4030
B5031	*	PULEGGIA 1 GOLA Ø 230 X 25	1-RACE PULLEY Ø 230 X 25	SEILROLLE Ø 230 X 25	POULIE 2 GORGE Ø 230X31	POLEA 1 CANALES Ø 230X25
B5032	*	PULEGGIA 2 GOLA Ø 230 X 31	2-RACE PULLEY Ø 230 X 31	SEILROLLE Ø 230 X 31	POULIE 1 GORGE Ø 230X 31	POLEA 2 CANALES Ø 230X31
B5033		LAMA FERMAPERNO	PIN STOPPING PLATE	ZAPFENSPEERBLATT	ARRÊTOIR	CHAPA CIERRA-PERNO
B5034		VITE TSPEI M8X12 UNI 5933	SCREW TSPEI M8X12 UNI 5933	SCHRAUBE TSPEI M8X12 UNI 5933	VIS TPSCE M 8 X 12 UNI 5933	TORNILLO TPSCE M8X12 UNI 5933
B5035		TIRANTE MAGNETE 430	MAGNET TIE ROD	ZUSTANGE MAGNETE	TIRANT POUR MAGNET	TIRANTE ELECTROIMÁN
B5041		TIRANTE PERNO AZIONAMENTO DX	RIGHT PIN BOLT	SPANNSTANGE DES ANTRIEBSZAPFENS RECHTS	TIRANT POUR GOUJON D'ACTIONNEMENT DX	TIRANTE PERNO ACCIONAMIENTO
B5044		DADO M M22 X 1,5 UNI 5588	NUT M22 X 1.5 UNI 5588	MUTTER M22 X 1,5 UNI 5588	ÉCROU M22 X 1,5 UNI 5588	TUERCA M22X1, 5 UNI 5588
B5045	*	KIT GUARNIZIONI CILINDRO	CYLINDER GASKET KIT	SET ZYLINDERDICHTUNGEN	KIT JOINTS DE VÉRIN	JUEGO DE JUNTAS CILINDRO
B5046		STANTUFFO	PISTON	KOLBEN	PISTON	ÉMBOLO
B5047	*	RONDELLA DI TENUTA CON GUARNIZIONE 1/4"	GASKET WITH 1/4" SEAL	DICHTUNGSUNTERLEGSCHIEBE MIT DICHTUNG 1/4"	RONDELLE D'ÉTANCHÉITÉ 1/4"	ARANDELA DE CIERRE CON GUARNICIÓN 1/4"
B5049		PROLUNGA M-F 1/4"	EXTENSION	DISTANZSTÜCK	RALLONGE	DISTANCIADOR
B5050		TESTATA	CYLINDER HEAD	ZYLINDERKOPF	TÊTE DE VÉRIN	CABEZAL
B5051		GIOGO	BEAM	ZYLINDERZUGSEIL	PALONNIER	YUGO DE APOYO
B5053	*	VITE FORATA 1/4	SCREW 1/4	SCHRAUBE 1/4"	BOUCHON RENIFLARD 1/4"	TORNILLO CON ORIFICIO 1/4"
B5055		MORSETTO	CLAMP	KLEME	BORNIER	MORDAZA
B5057	*	PULEGGIA 1 GOLA Ø230 X 40 + BRONZINA MBI C85-4040	1-RACE PULLEY Ø230 X 40 + BUSHING MBI C85-4040	RIEMENSCHIEBE 230X40 1 KEHLE	POULIE 1 GORGE 230X40+COUSSINET	POLEA 1 CANAL 230X40+COJINETE
B5059	*	DISTANZIALE Ø40 X 9	SPACER Ø40 X 9	DISTANZSTUECK Ø40X9	ENTRETOISE Ø40X9	DISTANCIADOR Ø40X9
B5060	*	DISTANZIALE Ø40X27	SPACER Ø40X27	DISTANZSTUECK Ø40X27	ENTRETOISE Ø40X27	DISTANCIADOR Ø40X27
B5062	*	KIT VALVOLA BLOCCA CILINDRO	CYLINDER SAFETY VALVE ASSEMBLY	ZYLINDERSPEERVENTIL	ENSEMBLE CLAPET PARACHUTE	KIT VÁLVULA DE BLOQUEO
B5063		TIRANTE PERNO AZIONAMENTO SX	LEFT PIN BOLT	SPANNSTANGE DES ANTRIEBSZAPFENS LINKS	TIRANT POUR GOUJON D'ACTIONNEMENT SX	TIRANTE PERNO ACCIONAMIENTO
B5068		PERNO ANTISCARRUCOLAMENTO Ø16 X 101	SAFETY PIN Ø16 X 101	STIFT Ø16 X 101	AXE DE MAINTIEN DE CÂBLE Ø 16X101	PERNO ANTI-DESCARRILAMIENTO Ø16X101
B5069		PERNO GUIDA ASTE DI SICUREZZA	SAFETY ROD PIN	STIFT	AXE GUIDE-CRÉMAILLÈRE	PERNO GUÍA BARRA DE SEGURIDAD
B5070		PERNO Ø20 X 101	PIN Ø20 X 101	STIFT Ø20 X 101	AXE Ø20X101	PERNO Ø20X101
B5071		PERNO PULEGGIE TRAVERSE Ø40 X 104	CROSSPIECE PULLEY PIN Ø40 X 104	STIFT Ø40 X 104	AXE DE POULIE DE TRAVERSE Ø 40X104	PERNO POLEA TRAVESAÑO Ø40X104
B5075	*	PATTINO LATERALE Ø35X10	SIDE SLIDING PAD Ø35X10	SEITLICHER GLEITSCHUH Ø35X10	PATIN LATÉRAL Ø35X10	PATÍN LATERAL Ø35X10
B5076		PATTINO POSTERIORE Ø35 X 17	REAR SLIDING PAD Ø35 X 17	GLEITSTUECK HINTEN Ø35 X 17	PATIN ARRIÈRE Ø35X17	PATÍN POSTERIOR Ø35X17
B5080		TIRANTE TASTAFUNE	ROPE -FEELER TIE ROD	ZUGSTANGE SEILTASTER	TIRANT DE PALPEUR DE CÂBLE	TIRANTE
B5085		DADOBK BASSO M 6 6S. UNI 7474	SELF-LOCKING NUT M6	SELBSTSICHERNDE MUTTER M6	ECROU FREIN M6 UNI 7474	TUERCA AUTOBLOCANTE M6 UNI 7474
B5087		MOLLA INFERIORE RICHIAMO MARTELLETTI	WEDGE RETURN BOTTOM SPRING	FEDER KEILRUECKHOLUNG	RESSORT DE RAPPEL DE TAQUET	MUELLE RETORNO
B5088		DADO BLOK M8 UNI 7474	NUT M8 UNI 7474	MUTTER BLOCK. M8 UNI 7474	ECROU FREIN M8 UNI 7474	TUERCA AUTOBLOCANTE M8 UNI 7474
B5108		MORSETTO PER CAVO Ø2,5 MM.	CABLE CLAMP Ø2.5 MM	KABELKLEMME Ø2,5 MM.	SERRE-CÂBLE Ø2,5 MM	MORDAZA PARA CABLE Ø2,5 MM.
B5113		MORSETTIERA MAMMUTH 4 POLI T.L.C.	CONTROL SIDE CROSSPIECE 4-POLE TERMINAL BOARD	KLEMMLEISTE MAMMUTH 4 POLE KOMMANDOSEITE	BOÎTE À BORNES MAMMUTH 4 PÔLES POUR TRAVERSE CÔTÉ COMMANDES	JUEGO TERMINALES MAMMUTH 4 POLOS T.L.C.
B5116		TIRANTE PIEGATO	BENT TIE ROD	ZUGSTANGE	TIRANT COUDÉ	TIRANTE ACODADO
B5120		SCATOLA DI DERIVAZIONE T.L.O.	OPERATOR SIDE CROSSPIECE CONNECTOR BLOCK	UMLEITERDOSE	COMMANDEZ LE BORNIER LATÉRAL DE CROSSPIECE	CAJA DE DERIVACIÓN T.L.O.
B5122		MORSETTIERA MAMMUTH 2 POLI T.L.C.	CONTROL SIDE CROSSPIECE 2-POLE TERMINAL BOARD	KLEMMLEISTE MAMMUTH 2 POLE	BORNIER MAMMUTH 2 PÔLES POUR TRAVERSE ARRIÈRE	JUEGO TERMINALES MAMMUTH 2 POLOS T.L.C.

B5124		MARTELLETTO DI SERVIZIO DX	RIGHT AUXILIARY WEDGE	HAMMER RECHTS	MARTEAUX DE SERVICE-DROITE	CUÑA DE SERVICIO DCHA.
B5125		MARTELLETTO DI SERVIZIO SX	LEFT AUXILIARY WEDGE	HAMMER LINKS	MARTEAUX DE SERVICE-GAUCHE	CUÑA DE SERVICIO IZDA.
B5154		COPIGLIA 3X40 UNI 1336	ZINC-PLATED COTTER PIN Ø3X40	VERZINKT SPLINTE Ø3X40	GOUPILLE Ø3X40 GALVANISÉE	PASADOR Ø3X40 ZINCADO
B5166		ASTA DI SICUREZZA	SAFETY ROD	KLINKENATANGE	CRÉMAILLÈRE DE SÉCURITÉ	BARRA DE SEGURIDAD
B5171		ASTA PER RAMPA DI SALITA	DRIVE ON RAMP PIN	BEFESTIGUNGSBOLZEN	TIGE CHARNIERES	PASADOR BISAGRA
B5180	*	FINECORSA DI DISCESA PIZZATO FR 754	DESCENT LIMIT SWITCH PIZZATO FR 754	ABSTIEGENSCHALTER PIZZATO FR 754	FIN DE COURSE DE DESCENTE PIZZATO FR 754	FINAL DE CARRERA BAJADA PIZZATO FR 754
B5186		SFERA PIASTRE OSCILLANTI	BALL FOR OSCILLATING PLATES	KUGEL FÜR SCHWINGENDE PLATTEN	PLAQUE DE RETENUE DE CHEMIN DE ROULEMENT	ESFERA PLACAS OSCILANTES
B5191	*	BRONZINA Ø 40 X 44 X 40 MBI - CB85 - 4020	BUSHING Ø 40 X 44 X 40 MBI - CB85 - 4020	LAGERBUCHSE Ø 40 X 44 X 40 MBI - CB85 - 4020	COUSSINET Ø 40 X 44 X 40 MBI - CB85 - 4020	COJINETE Ø 40 X 44 X 40 MBI - CB85 - 4020
B5196		CAPPELLO COLONNA	POST CAP	SÄULENABDECKUNG	BILLE PLATEAUX OSCILLANTS	CUBIERTA DE PLÁSTICO
B5197		RULLO LATERALE	SIDE ROLL	ROLLE	CAPOT COLONNE	RODILLO
B5199	*	FUNE "K"	ROPE "K"	SEIL "K"	CÂBLE "K"	CABLE "K"
B5200	*	FUNE "X"	ROPE "X"	SEIL "X"	CÂBLE "X"	CABLE "X"
B5204		CILINDRO COMPL.450LT-ATLT	COMPLETE CYLINDER	ZYLINDER KOMPLETT	VEREIN COMPLÈTE	CILINDRO COMPLETO
B5253		PRESSACAPO PG 13.5	PG 13.5 CABLE HOLDER	KABELBUCHSE	SERRE-CABLE	PASACABLE
B5266		AZIONATORE FINECORSA	LIMIT SWITCH ACTUATOR	ENDSCHALTERTIEB	CAME DE FIN DE COURSE	ACCIONADOR FINAL DE CARRERA
B5276		RULLO CENTRALE	CENTRAL ROLL	ROLLE	ROULEMENT CENTRAL	RODILLO
B5277XX		PIANALE TORRETTA L.C.	COMMAND SIDE TURRET PLATFORM	AUFSATZPLATTFORM	PLATE-FORME TOURELLE	PLATAFORMA PLATAFORMA AUXILIAR
B5278XX		PIANALE TORRETTA L.O.	OPPOSITE SIDE TURRET PLATFORM	AUFSATZPLATTFORM	PLATE-FORME TOURELLE	PLATAFORMA PLATAFORMA AUXILIAR
B5279XX		LEVA INTERNA	INSIDE LEVER L.T.	HEBEL	LEVIER INTERNE	PALANCA
B5280XX		LEVA ESTERNA	EXTERNAL LEVER L.T.	HEBEL	LEVIER EXTERNE	PALANCA
B5281XX		PROLUNGA	TURRET PLATFORM EXTENSION	FAHRSCHIENEN	RALLONGE	DISTANCIADOR
B5282		PERNO UNIONE LEVE	L.T. LEVER UNION PIN	STIFT	AXE BRAS	PERNO
B5284XX		CHIUSURA INCAVO ANTERIORE	ENCLOSE RECES	DECKEL	COUVERCLE	TAPA
B5291		RELÈ FINDER 24VAC 55.32.9.024.0040	RELAY FINDER 24VAC 55.32.9.024.0040	HUBRELAIS FINDER 24VAC 55.32.9.024.0040	RELAIS FINDER 24VAC 55.32.9.024.0040	RELÉ FINDER 24VAC 55.32.9.024.0040
B5292		RELÈ FINDER 24VAC 55.34.9.024.0040	RELAY FINDER 24VAC 55.34.9.024.0040	HUBRELAIS FINDER 24VAC 55.34.9.024.0040	RELAIS FINDER 24VAC 55.34.9.024.0040	RELÉ FINDER 24VAC 55.34.9.024.0040
B5293	*	FUSIBILE RITARDATO 5X20 4A T	FUSE 5X20 4A T	SCHMELZSICHERUNG 5X20 4A T	FUSIBLE 5X20 4A T	FUSIBLE 5X20 4A T
B5294	*	SCHEDA ELETTRICA M00GIOSCH20_02-04	ELECTRIC BOARD M00GIOSCH20_02-04	ELEKTRONIK-KARTE M00GIOSCH20_02-04	PLATINE ÉLECTROMÉCANIQUE M00GIOSCH20_02-04	PLATCA ELECTRONICA
B5300		VITE TCTC 3,9X19 UNI 69543	SCREW 3,9X19	SCHRAUBE TCTC 3,9X19 UNI 69543	VIS TCTC 3,9X19 UNI 69543	TORNILLO TCTC 3,9X19 UNI 69543
B5301		RALLA A/S 30X47X1	FIFTH WHEEL	SCHWENKSATTEL	BERCEAU	RALLA
B5302		RONDELLA ACC/NBR 3/8 17,3X23,9X2,1	WASHER 17,3X23,9X2,1	SCHEIBE 3/8 17,3X23,9X2,1	RONDELLE 3/8 17,3X23,9X2,1	ARANDELA
B5303		VITE FORATA 3/8	HOLED SCREW*	SCHRAUBE 3/8	BOUCHON RENIFLARD 3/8"	TORNILLO
B5311		TUBO SECONDARIO 450LT ATLT	SECONDARY HOSE	SCHLAUCH	FLEXIBLE SECONDAIRE	TUBO
B5312XX		TRAVERSA L.C.450LT ATLT 3002	CROSSPIECE COMMAND SIDE	TRAVERSE	TRAVERSES CÔTÉ COMMANDES	TRAVESAÑO L.C.
B5313XX		TRAVERSA L.O.450LT ATLT 3002	CROSSPIECE OPPOSITE SIDE	TRAVERSE	TRAVERSES CÔTÉ OPPOSÉE AUX COMMANDES	TRAVESAÑO L.O.
B5315XX		CARTER TRAVERSA 450LT ATLT	CROSSPIECE CASING	GEHÄUSE	CARTER TRAVERSES	CÁRTER
B5318	*	PERNO PULEGGE L92	PULLEY PIN L92	STIFT L=92	AXE L=92	PERNO L=92
B5319	*	PERNO L=121	PIN L=121	STIFT L=121	AXE L=121	PERNO L=121
B5322		PERNO X LEVA 450LT ATLT	LEVER PIN	STIFT	AXE BRAS LT	PERNO
B5324		PERNO X CIL.TEL.L80 450LT ATLT	CYLINDER PIN L80	STIFT	AXE VERIN L80	PERNO
B5326		STANTUFFO PRIMARIO	PRIMARY PISTON	KOLBEN	PISTON PRIMAIRE	ÉMBOLO

B5327		STANTUFFO X CIL.SEC.450LT ATLT	SECONDARY PISTON	KOLBEN	PISTON SECONDAIRE	ÉMBOLO
B5328		TESTATA CILINDRO PRIMARIO	PRIMARY CYLINDER HEAD	ZYLINDERKOPF	TÊTE DE VÉRIN PRIMAIRE	CABEZAL CILINDRO
B5329		TESTATA CILINDRO SECONDARIO	SECONDARY CYLINDER HEAD	ZYLINDERKOPF	TÊTE DE VÉRIN SECONDAIRE	CABEZAL CILINDRO
B5332		PERNO LEVA PORTA PULEGGIA D30X63	PIN LEVER-PULLEY	STIFT	AXE LEVIER	PERNO PALANCA
B5335		CILINDRO 450LT ATLT	CYLINDER	ZYLINDER KOMPLETT	VEREIN COMPLÈTE	CILINDRO COMPLETO
B5336		PISTONE 450LT ATLT	PISTON	KOLBEN	PISTON	PISTÓN
B5337XX		PEDANA L.C.	COMMAND SIDE PLATFORM WITHOUT RECESS	AUFNAHMEPLATTFORM	PLATE-FORME DE ROULEMENT CÔTE COMMANDE	PLATAFORMA
B5338XX		PEDANA L.O.	PLATFORM L.O.	FAHRSCHEIENE L.O.	PLATE-FORME	PLATAFORMA
B5342		STELO PER CIL.450LT ATLT	CYLINDER ROD	ZYLINDER WELLE	AXE VERIN	VÁSTAGO CILINDRO
B5343XX		COLON.2-4 450LT ATLT 3002	POST 2-4	SÄULE 2-4	COLONNE 2-4	COLUMNNA 2-4
B5344XX		COLON.3 450LT ATLT 3002	POST 3	SÄULE 3	COLONNE 3	COLUMNNA 3
B5345XX		COLON.1 450LT ATLT 3002	POST 1	SÄULE 1	COLONNE 1	COLUMNNA 1
B5346	*	KIT GUARNIZ.CIL.PRIMARIO 450LT	PRIMARY CYLINDER GASKETS KIT	SET DICHTUNG	JEU DE JOINTS POUR VERIN PRIMAIRE	JUEGO DE JUNTAS
B5347	*	KIT GUARNIZ.CIL.SECOND.450LT	SECONDARY CYLINDER GASKETS KIT	SET DICHTUNG	JEU DE JOINTS POUR VERIN SECONDAIRE	JUEGO DE JUNTAS
B5348		SUPPORTO CILINDRO 450LT ATLT	CYLINDER SUPPORT	HALTER	SUPPORT VERIN	SOPORTE
B5351		PULEGGIA D72 RINVIO FUNE+ BRONZINA	PULLEY Ø72 + BUSHING	SCHEIBEN	POULIE	POLEA + COJINETE
B5352		ASTA DI SICUREZZA 450LT-ATLT	SAFETY ROD	SCHERHEITS-ZAHNSTANGE	POINTEAU DE SÉCURITÉ	BARRA DE SEGURIDAD
B5353		PERNO LEVERISMO ZEPPA L.T	LEVER LT WEDGE PIN	STIFT	AXE	PERNO
B5356		ZEPPA LIFT TABLE 450LT-ATLT	LIFT TABLE SECURITY WEDGE	KEIL	TAQUET	CUÑA
B5378		VALVOLA DI TRAVASO CILINDRO D170	TRANSFER VALVE CYLINDER Ø70	VENTIIL	CLAPET	VÁLVULA
B5379		PERNO SUP.CILINDRO ASTA SICUREZZA	LT ROD-CYLINDER PIN	STIFT	AXE	PERNO
B5387XX		RAMPA SALITA 9005	RISE RAMP	AUFFAHRRAMPE	RAMPE DE MONTÉE	RAMPA DE ACCESO
B5391	*	PATTINO LATERALE TRAVERSA	LATERAL PAD	GLEITSCHU	PATIN DE LATÉRAL	PATÍN LATERAL
B5395		KIT FISSAGGIO SERBATOI IN PVC	TANK FASTENING KIT	TANK-BEFESTIGUNGSSET	ENSEMBLE FIXATIONS RESERVOIR	JUEGO SUJECION DEPOSITO
B5414	*	MOLLA SUPERIORE RICHIAMO MARTELLETTI	WEDGE RETURN TOP SPRING	FEDER	RESSORT	MUELLE
B5419		TAPPO X PIOMBATURA VM15	PLUG	DECKEL	BOUCHON	TAPÓN
B5422		SERBAT.L12 PVC NERO CENTR.K3	TANK	BEÄHELTER	RÉSERVOIR	DEPÓSITO
B5425	*	FILTRO ASPIRAZIONE 3/8"	AIR FILTER	ANSAUGFILTER	FILTRE ASPIRATION	FILTRO DE ASPIRACION
B5429		TAPPO DIN 908 1/4+RONDELL.RAME	PLUG	DECKEL	BOUCHON	TAPÓN
B5436		POMPA 18 10A5X348N SCC/REV	PUMP	PUMPE	POMPE	BOMBA
B5441	*	VALVOLA DI RITEGNO 3/8" KE	CHECK VALVE	RUECKSCHLAGVENTIL	CLAPET ANTI-RETOUR	VALVULA DE NO RETROCESO
B5442	*	VALVOLA DI MASSIMA15 80-250BAR	MAX. PRESSURE VALVE15 80-250BAR	UEBERDRUCKVENTIL15 80-250BAR	CLAPET DE PRESSION MAX.15 80-250BAR	VALVULA DE MAXIMA PRESION15 80-250BAR
B5447		RONDELLA BONDED M12 GM504	WASHER	UNTERLEGSCHIEBE	ARANDELA	RONDELLE
B5448		TUBO DI SCARICO 1/4 BSPT L=200	DRAIN PIPE	ABLASSROHR	TUBE DE RETOUR	TUBO DE DESCARGA
B5455		RULLO PER RAMPA D30/D16 L=50	RAMP ROLLER	FFUEHRUNGSBUCHSE	ROULEAU RAMPE BASCULANTE	RODILLO RAMPA BASCULANTE
B5456		RULLO PER RAMPA D30/D16 L=25	RAMP ROLLER	FFUEHRUNGSBUCHSE	ROULEAU RAMPE BASCULANTE	RODILLO RAMPA BASCULANTE
B5459	*	SENSORE TASTA FUNE DX	RIGHT ROPE -FEELER SENSOR	SEILABTASTSENSOR RECHTS	PALPEUR DE CÂBLE DROIT	PALPEUR DE CÂBLE DROIT
B5460	*	SENSORE TASTA FUNE SX	LEFT ROPE -FEELER SENSOR	SEILABTASTSENSOR LINKS	PALPEUR DE CÂBLE GAUCHE	SENSOR CABLE IZDA.
B5488		CORPO COLLARE DOPPIO 1/4	DOUBLE COLLAR BODY 1/4	KÖRPER	CORP	CUERPO
B5489		CORPO COLLARE SINGOLO D19	SINGLE COLLAR BODY	KÖRPER EINZELNER BUNDRING Ø19	CORP	CUERPO
B5491		GIUNTO POMPA K3	CONNECTING PUMP K3	GELENK PUMPE K3	ACCOUPLLEMENT DE POMPE K3	ACOPLAMIENTO BOMBA K3

B5496		STELO CILINDRO PRIM.C/FR 450LT	PISTON LT PRIMARY CYLINDER WITH BRAKE	ZYLINDER WELLE	TIGE DE VÉRIN	VÁSTAGO CILINDRO
B5556		TUBO SCARICO L=337 CENTR.LT/JC	DRAIN PIPE	ABLASSROHR	TUBE DE RETOUR	TUBO DE DESCARGA
B5557		COLONNETTA F-F 3/8" H=120	STUND BOLT F-F 3/8" H=120	BUNDSCHRAUBE F-F 3/8" H=120	COLONNETTE F-F 3/8" H=120	TUBO DE ROSCA F-F 3/8" H=120
B5558		COLONNETTA FRANGIFLUSSO M12X1	STUND BOLT M12X1	BUNDSCHRAUBE M12X1	COLONNETTE M12X1	TUBO DE ROSCA M12X1
B5654	*	PULSANTE NERO + 1 CONTATTO N.O.	BLACK PUSH-BUTTON + 1 N.O. CONTACT	DRUCKKNOPF	BOUTON	PULSADOR
B5655	*	PULSANTE NERO + 2 ELEM. CONT. N.O.	BLACK PUSH-BUTTON + 2 N.O. CONTACTS	DRUCKKNOPF	BOUTON	PULSADOR
B5659	*	FUSIBILE RITARDATO 10X38 2A AM	FUSE 10X38 2A AM	SCHMELZSICHERUNG	FUSIBLE	FUSIBILE
B5665		PASSAGUAINA GEWISS Ø20MM	SHEATH HOLDER GEWISS Ø20MM	KABELMANTEL DURCHGANG GEWISS Ø20MM	FUSIBLE 10X38 2A AM	PASACABLE D20
B5671	*	INTERRUTTORE GENERALE	MAIN SWITCH	SCHALTER	INTERRUPTEUR	INTERRUPTOR
B5672	*	PULSANTE GRIGIO +2 CONT.N.O.+1 CONT.N.C.	GREY PUSH-BUTTON + 2 N.O. CONTACTS + 1 N.C. CONTACT	GRAU DRUCKKNOPF+ 2 KONTAKTS N.O. + 1 KONTAKT N.C.	POUSSOIR GRIS + 2 CONTACTS N.O.+1 CONT.N.C.	PULSADOR
B5673	*	PULSANTE VERDE + 2 CONT. N.O.	GREEN PUSH-BUTTON + 2 N.O. CONTACTS	GRÜNER DRUCKKNOPF+ 2 N.O. KONTAKTS	POUSSOIR GRIS + 2 CONTACTS N.O. + 1 CONTACT N.C.	PULSADOR VERDE
B5674	*	SELETTORE 3 POS +2 CONT.N.O.+2 CONT.N.C.	SELECTOR SWITCH 3 POSITION + 2 N.O. CONTACTS + 2 N.C. CONTACT	UMSCHALTER AUFSATZPLATTFORM	POUSSOIR VERT + 2 CONTACTS N.O.	SELECTOR
B5676		CENTRALINA K3	GEARCASE	GERAET	CENTRALE	CENTRALITA
B5678		COLLETTORE KE2000 M16/Z 80-250BAR	MANIFOLD	KOLLEKTOR	COLLECTEUR	COLECTOR
B5680	*	EL.VALV. 3 VIE COMPL.CENTRAL.K3	3 WAY COMPLETE ELECTRO-VALVE	ELEKTROVENTIL KOMPLETT	ELECTROVANNE COMPLÈTE	ELECTROVÁLVULA COMPLETA
B5681	*	VALVOLA V3D-DT-CEI	VALVE V3D-DT-CEI	VENTIL	SOUPAPE	VÁLVULA
B5684		VALVOLA STF38 9L/MIN	VALVE STF38 9L/MIN	VENTIL	SOUPAPE	VÁLVULA
B5686	*	BOBINA S4-CEI 24V 26W+CONNETTORE	COIL S4-CEI 24V 26W+ CONNECTOR	SPULE	BOBINE	BOBINA
B5688		GUAINA Ø20MM DIFLEX	SHEATH Ø20MM DIFLEX	KABELMANTEL Ø20MM DIFLEX	PRESSE-ÉTOUPE GEWISS Ø20MM	MANGUERA
B5764		CILINDRO PRIMARIO LT 450LT/06	LT MAIN CYLINDER	ZYLINDER KOMPLETT	VÉRIN PRIMAIRE	CILINDRO COMPLETO
B5765		CILINDRO SEC.LT COMP.450LT/06	LT SECONDARY CYLINDER	ZYLINDER	VÉRIN SECONDAIRE	CILINDRO
B5766		CANNA CIL.PRIM.450LT/06	LT MAIN CYLINDER TUBE	ZYLINDERROHR	CYLINDRE DE VÉRIN	CAÑA CILINDRO
B5767		CANNA CIL.SECON.450LT/06	LT SECONDARY CYLINDER TUBE	ZYLINDERROHR	CYLINDRE DE VÉRIN	CAÑA CILINDRO
B5768		CILINDRO PNEUM.450LT/06	PNEUMATIC CYLINDER	ZYLINDER	VÉRIN	CILINDRO
B5780		QUADRO/T 400+SCHEDA	ELECTRIC BOX	KASTEN DREHSTROM	COFFRET ÉLECTRIQUE	CAJA ELÉCTRICA TRIFÁSICA
B5788	*	RONDELLA IN NYLON	NYLON WASHER	SCHEIBE	RONDELLE	ARANDELA
B5832		VALVOLA TRAVASO CIL.DI80FR 443	TRANSFER VALVE LT PRIMARY CYLINDER WITH BRAKE	VENTIL	CLAPET VÉRIN Ø70 AVEC FRAIN	VALVULA
B5848		SUPPORTO MICROVALVOLA	MICROVALVE SUPPORT	HALTER DRUCKLUFTMIKROVENTIL	SUPPORT MICRO VANNE PNEUMATIQUE	SOPORTE
B5849		RACCORDO A "Y" 1/4M-Ø8 S6450	QUICK "Y" CONNECTION M1/4"-Ø8 S6450	ANSCHLUSS "Y" 1/4M-Ø8 S6450	RACCORD "Y" 1/4M-Ø8 S6450	RACOR "Y" 1/4M-Ø8 S6450
B5850		CENTRAL.K3/T COMPL.2.2KW 4COLON.	GEARCASE	GERAET	CENTRALE	CENTRALITA
B5851		CASSETTA	ELECTRIC BOX	KASTE	CENTRALE COMPLETE K3	CAJA ELÉCTRICA
B5852	*	PULSANTE NERO +1 CONT. N.O.+1CONT. N.C.	BLACK PUSH-BUTTON 1 N.O. CONT.+1N.C. CONT	SCHWARTZ DRUCKKNOPF+1 KONTAKT N.C.+ 1 KONTAKT N.O.	POUSSOIR NOIR + 1 CONTACT N.O. + 1CONTACT N.C.	PULSADOR
B5853	*	PULSANTE NERO + 1 CONT. N.C.+ 2 CONT. N.O.	BLACK PUSH-BUTTON + 1 N.C. CONTACT + 2 N.O. CONTACTS	SCHWARTZ DRUCKKNOPF+1 KONTAKT N.C.+ 2 KONTAKT N.O.	POUSSOIR NOIR+ 1 CONTACT N.C. + 2 CONTACTS N.O.	PULSADOR
B5863		VITE FORATA 1/4 PER MANOMETRO	HOLED SCREW ¼ FOR GAUGE	DECKEL	BOUCHON	TAPÓN
B5885XX		KIT RAMPA SALITA	RISE RAMP KIT	SET AUFFAHRRAMPE	ENSEMBLE RAMPE	KIT RAMPA DE ACCESO
B5930XX		FERMARUOTA	WHEEL STOP	RADSPERRBLECH	ARRET-ROUES	TOPE DE RUEDA
B5931		VITE TE M12X100 UNI 5739	SCREW M12X100 UNI 5739	SCHRAUBE M12X100 UNI 5739	VIS M12X100 UNI 5739	TORNILLO M12X100 UNI 5739

B5934		TUBO FLESS.450LT-06	FLEXIBLE PIPE	AUSGUSS SCHLAUCH OEL	FLEXIBLE HAUTE	TUBO FLEXIBLE
B5935		VITE TCCE M12X80 UNI 5931 ZN	SCREW M12X80 UNI 5931 ZN	SCHRAUBE M12X80 UNI5931	VIS M12X80 UNI5931	TORNILLO M12X80 UNI5931
B5943		COPRIMORSETTIERA MOTORE	MOTOR TERMINAL BOARD COVER	KLEMMENBRETTABDECKUNG	COUVERCLE BORNIER	TAPA CAJA DE BORNES
B5945		COPRIVENTOLA MOTORE	MOTOR AIR-CONVEYOR	LUEFTERABDECKUNG	PROTECTION DU VENTILATEUR	PROTECCION VENTILADOR
B5950XX		PEDANA L.C.450LT ASSETTO	PLATFORM	AUFNAHMEPLATTFORM	PLATE-FORME	PLATAFORMA
B5951XX		PEDANA L.O.450LT ASSETTO	PLATFORM	AUFNAHMEPLATTFORM	PLATE-FORME	PLATAFORMA
B5952		PIASTRA OSCIL.COMPL.450LT-ATLT	OSCILLATING PLATE	SCHWINGENDE PLATTE	PLATEAU OSCILLANT	PLACA OSCILANTE
B5953		PIASTRA SUP.ASSET.RUOTE 450ATL	PLATE	PLATTE	PLAQUE	PLACA
B5954		TELAIO INF.ASS.RUOTE450ATLT 07	LOWER FRAME	GESTELL	CHASSIS	BASTIDOR
B5958		SPIRALE 50X40 PER TUBAZIONI	SPIRAL FOR HOSES	SPIRALSCHLAUCH	SPIRALE RILSAN	SPIRALE RILSAN
B5961	*	PATTINO GIOGO	BEAM SLIDING PAD	GLEITSCHUH	PATIN	PATÍN
B5983	*	ELETTROMAGNETE E0425 24V CC 50Hz	ELECTROMAGNET E0425 24V CC 50H	ELEKTROMAGNET E0425 24V CC 50H	ELECTRO-AIMANT E0425 24V CC 50H	ELECTROIMÁN E0425 24V CC 50H
B6021		KIT STAFFA SUPPORTO	SUPPORT BRACKER KIT	HALTERUNGSBÜGELSET	SUPPORT COMPLET AVEC VIS	KIT ESTRIBO SOPORTE
B6091		TAPPO SERBATOIO	TANK PLUG	TANKVERSCHLUß	BOUCHON DE RÉSERVOIR	TAPÓN DEPÓSITO
B6135XX		CARTER TRAVERSA L.C.	CASING	GEHÄUSE	CARTER	CÁRTER
B6136XX		CARTER PROTEZIONE MAGNETI	MAGNET PROTECTION CRANKCASE	ABDECKUNG MAGNETSCHUTZ	PROTECTION MAGNETS	CARTER PROTECCIÓN ELECTROIMÁN
B6155		TUBO PRIMARIO	PRIMARY HOSE	SCHLAUCH	FLEXIBLE PRIMAIRE	TUBO
B6511		PORTAFUSIBILE 10X38 WIMEX PCH1	FUSE HOUSING 10X38 WIMEX PCH10X38	SCHMELZSICHERUNGHALTER	PORTE-FUSIBLE 10X38 WIMEX PCH 10X38	PORTAFUSIBLES 10X38 WIMEX PCH1
B6513		PASSACAVO GEWISS PG 9	CABLE CLAMP GEWISS PG9	KABELDURCHGANG GEWISS PG 9	PASSE-CÂBLE GEWISS PG9	PASACABLE GEWISS PG9
B6514		PASSACAVO GEWISS PG11	CABLE CLAMP GEWISS PG11	KABELDURCHGANG GEWISS PG11	PRESSE-ÉTOUPE GEWISS PG11	PASACABLE GEWISS PG11
B6515	*	TRASFORMATORE230-400/24V 300VA 50/60HZ	TRANSFORMER 230-400/24V 300VA 50/60HZ	TRANSFORMATOR	TRANSFORMATEUR	TRANSFORMADOR
B6516	*	INTERRUPTORE MAGNETICO 20A TYPE C	MAGNET SWITCH 20A TYPE C	MAGNETSCHALTER SIEMENS QS20A	INTERRUPTEUR MAGNÉTIQUE SIEMENS QS20A	INTERRUPTOR MAGNÉTICO SIEMENS QS20A
B6521		GUAINA Ø20MM DIFLEXCON CAVI	SHEATH Ø20MM DIFLEX WITH CABLES	KABELMANTEL Ø20MM DIFLEX MIT KABLE	PRESSE-ÉTOUPE GEWISS Ø20MM AVEC CABLES	MANGUERA CON CABLES
B6522		MORSETTO SPRECHER VU4-4	TERMINAL SPRECHER VU4-4	KLEMME SPRECHER VU4-4	BORNIER SPRECHER VU4-4	TERMINAL SPRECHER VU4-4
B6592	*	MOTORE TRIFASE 230/400V 50HZ 2,2KW-K3	MOTOR 3PHASE 230/400V 50HZ 2,2KW-K3	ELEKTRO-MOTOR B14 230-400/50T 3KW 4CO.K3	MOTOR B14 230-400/50T 3KW 4CO.K3	MOTOR ELÉCTRICO B14 230-400/50T 3KW 4CO.K3
C0042		RACCORDO RAP.DIR.M 1/8X6	QUICK MALE CONNECTION 1/8" X PIPE 6	SCHNELLANSCHLUß 1/8 X SCHLAUCH 6	RACCORD RAPIDE 1/8" X TUYAU 6	CONEXION RAPIDA M 1/8X6
C0043		VITE TE M6X10 UNI 5739	SCREW TE M6X10 UNI 5739	SECHSKANTSCHRAUBE M6X10 UNI 5739	VIS TH M6X10 UNI 5739	TORNILLO TE M6X10 ZINCADO
C0049		TAPPO M1/4	PLUG M1/4	SCHRAUBE 1/4"	BOUCHON RENIFLARD 1/4"	TORNILLO CON ORIFICIO 1/4"
C0051		TUBO RILSAN Ø4/6	RYLSAN HOSEØ4/6	SCHLAUCH 6X4	TUYAU RILSAN D.6X4	TUBO RILSAN Ø6X4
C0057		RACCORDO RAPIDO "L" 1/8"-Ø6 S6500	QUICK "L" CONNECTION 1/8"-Ø6 S6500	KNIESTÜCK 1/8" X SCHLAUCH Ø6	RACCORD "L" 1/8"	CONEXION "L"
C0061		VITE TE M8X10 UNI 5739	SCREW TE M8X10 UNI 5739	SECHSKANTSCHRAUBE M8X10 UNI 5739	VIS TH M8X10 UNI 5739	TORNILLO M8X10 UNI 5739
C0062		RONDELLA Ø10,5X21 UNI 6592	WASHER Ø10,5X21 UNI 6592	SCHEIBE Ø10,5X21	RONDELLE Ø10,5X21	ARANDELA PLANA Ø10 5X21
C0076		RACCORDO A "L" M-F 1/4 S2020	QUICK "L" CONNECTION M-F 1/4 S2020	L-ANSCHLUSS "L" M-F 1/4"	RACCORD "L" M/F 1/4"	CONEXION "L" M-F 1/4"
C0099		VITE TE 6X20 8.8 UNI 5739	SCREW M6X20 - 8.8	SCHRAUBE M6X20 8.8	VIS TH M6 X 20 UNI 5739	TORNILLO TE M6X20 UNI 5739
C0100		RONDELLA Ø8,4X17 UNI 6592	WASHER Ø8,4X17 UNI 6592	SCHEIBE Ø8,4X17 UNI 6592	RONDELLE Ø8,4X17 UNI 6592	ARANDELA Ø8 ZINCADA
C0105		VITE TE M8X30 UNI 5739	SCREW TE M8X30 UNI 5739	SECHSKANTSCHRAUBE M8X30 UNI 5739	VIS TH M8X30 UNI 5739	TORNILLO TE M8X30 ZINCADO
C0278		RACCORDO "L" GIREVOLE M M5X6	"L" CONNECTION M5X Ø6	"L"-ANSCHLUSS	RACCORD	CONEXION "L"
C0339		TUBO RILSAN 8X6 NERO	RILSAN HOSE 8X6	SCHLAUCH D.8X6	TUYAU RILSAN D.8X6	TUBO RILSAN Ø8X6

C0418		VITE AUTOFILETT. Ø2,9X9,5 UNI 6954	SELF TAPPING SCREW Ø2.9X9.5	KTC SENKSCHRAUBE 2,9X9,5 UNI 6954 ZB	VIS KTC TC 2,9X9,5 UNI 6954 ZB	TORNILLO
C0538		TAPPO M1/8"	PLUG M1/8"	STÖPSEL M1/8"	BOUCHON M 1/8"	TAPÓN MACHO G 1/8"
C0617		RONDELLA Ø6,4X12,5 UNI 6592	WASHER Ø6,4X12,5 UNI 6592	SCHEIBE Ø6,4X12,5 UNI 6592	RONDELLE Ø6,4X12,5 UNI 6592	ARANDELA Ø6,4X12,5 UNI6592
C0661		VITE TE M8X10 UNI 5739	HH SCREW M8X10 UNI 5739	SCHRAUBE M5 UNI 5587	VIS M5 UNI 5587	TORNILLO M5 UNI 5587
R0046		DADO MEDIO M12 UNI 5588	NUT M12	MUTTER M12 UNI 5588	ECROU M12 UNI 5588	TUERCA M12 UNI 5588
R0068		SEEGER E30 UNI 7435	SNAP RING E30 UNI 7435	SEEGER E30 UNI 7435	ANNEAU DE FIXAGE E30 UNI 7435	SEEGER E30 UNI 7435
R0153		VITE TE M8X25 UNI 5739	HH SCREW M8X25 UNI 5739	SECHSKANTSCHRAUBE M8X25 UNI 5739	VIS TH M8X25 UNI 5739	TORNILLO TE M6X25 UNI5739
R0158		DADO M8 UNI 5588	NUT M8 UNI 5588	MUTTER M8 UNI 5588	ECROU M8 UNI 5588	TUERCA M8 UNI 5588
R1006		DADOBLK M20X1.5 UNI 7474 ZB	SELF-LOCKING NUT M20X1.5 UNI 7474 ZB	MUTTER M20X1.5 UNI 7474	ÉCROU AUTOBLOQUANT M20X1.5 UNI 7474 ZB	TUERCA M20X1.5 UNI 7474
R2497		ANELLO SEEGER E16 UNI 7435	RETAINING RING E16 UNI 7435	SEEGER-RING E16 UNI 7435	CIRCLIPS E16 UNI 7435	SEEGER E16 UNI 7435
V926	*	TAMPONE GOMMA H=80 120X160	RUBBER PADS	GUMMISTOPFEN	TAMPON EN CAOUTCHOUC	TAMPÓN EN GOMA
Z_RICAMBI		* = RICAMBI CONSIGLIATI	* = RECOMMENDED SPARE PARTS	* = EMPFOHLENE E-TEILE	* = PIÉCES DE RECHANGE CONSEILLÉES	* = REPUESTOS ACONSEJAIOS